

E96-420

Bailey®  
**infi 90**

# Instruction

## Analog Input Calibration Module (NIAC02)

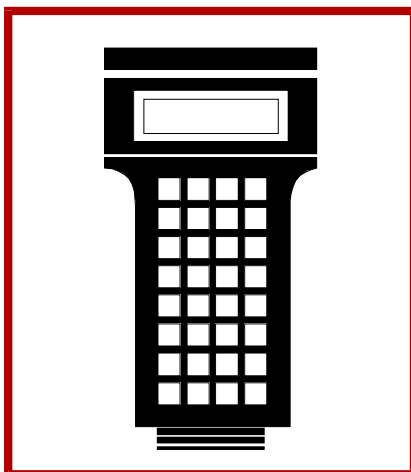
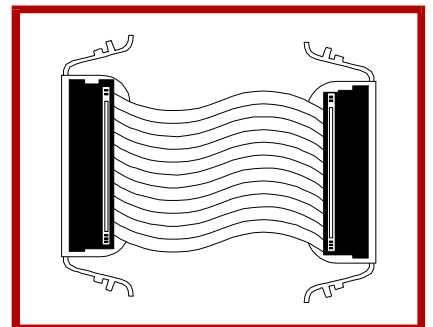
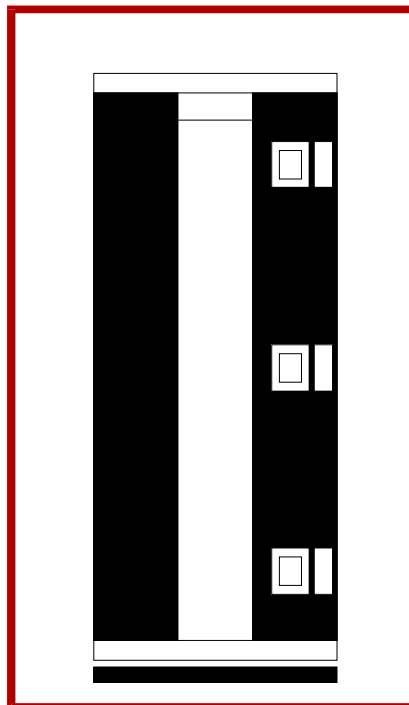
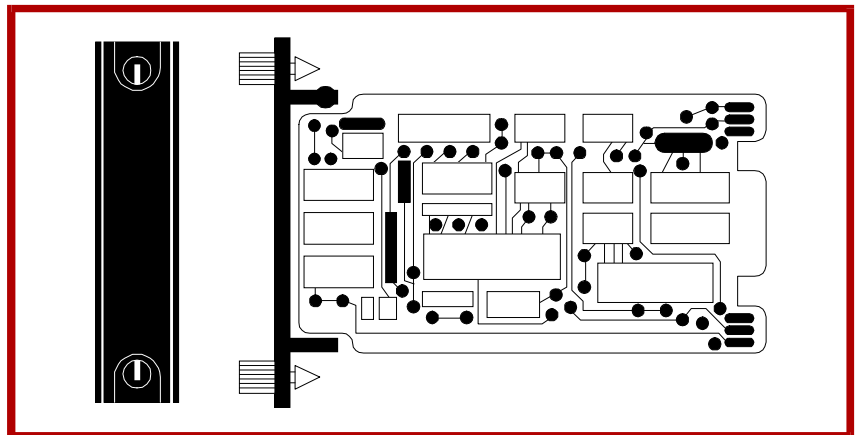

**WARNING** notices as used in this instruction apply to hazards or unsafe practices that could result in personal injury or death.

**CAUTION** notices apply to hazards or unsafe practices that could result in property damage.

**NOTES** highlight procedures and contain information that assists the operator in understanding the information contained in this instruction.

## WARNING

### INSTRUCTION MANUALS

DO NOT INSTALL, MAINTAIN, OR OPERATE THIS EQUIPMENT WITHOUT READING, UNDERSTANDING, AND FOLLOWING THE PROPER **Elsag Bailey** INSTRUCTIONS AND MANUALS; OTHERWISE, INJURY OR DAMAGE MAY RESULT.

### RADIO FREQUENCY INTERFERENCE

MOST ELECTRONIC EQUIPMENT IS INFLUENCED BY RADIO FREQUENCY INTERFERENCE (RFI). CAUTION SHOULD BE EXERCISED WITH REGARD TO THE USE OF PORTABLE COMMUNICATIONS EQUIPMENT IN THE AREA AROUND SUCH EQUIPMENT. PRUDENT PRACTICE DICTATES THAT SIGNS SHOULD BE POSTED IN THE VICINITY OF THE EQUIPMENT CAUTIONING AGAINST THE USE OF PORTABLE COMMUNICATIONS EQUIPMENT.

### POSSIBLE PROCESS UPSETS

MAINTENANCE MUST BE PERFORMED ONLY BY QUALIFIED PERSONNEL AND ONLY AFTER SECURING EQUIPMENT CONTROLLED BY THIS PRODUCT. ADJUSTING OR REMOVING THIS PRODUCT WHILE IT IS IN THE SYSTEM MAY UPSET THE PROCESS BEING CONTROLLED. SOME PROCESS UPSETS MAY CAUSE INJURY OR DAMAGE.

## AVERTISSEMENT

### MANUELS D'OPÉRATION

NE PAS METTRE EN PLACE, RÉPARER OU FAIRE FONCTIONNER L'ÉQUIPEMENT SANS AVOIR LU, COMPRIS ET SUIVI LES INSTRUCTIONS RÉGLEMENTAIRES DE **Elsag Bailey**. TOUTE NÉGLIGENCE À CET ÉGARD POURRAIT ÊTRE UNE CAUSE D'ACCIDENT OU DE DÉFAILLANCE DU MATÉRIEL.

### PERTURBATIONS PAR FRÉQUENCE RADIO

LA PLUPART DES ÉQUIPEMENTS ÉLECTRONIQUES SONT SENSIBLES AUX PERTURBATIONS PAR FRÉQUENCE RADIO. DES PRÉCAUTIONS DEVRONT ÊTRE PRISES LORS DE L'UTILISATION DU MATÉRIEL DE COMMUNICATION PORTATIF. LA PRUDENCE EXIGE QUE LES PRÉCAUTIONS À PRENDRE DANS CE CAS SOIENT SIGNALÉES AUX ENDROITS VOULUS DANS VOTRE USINE.

### PERTURBATIONS DU PROCÉDÉ

L'ENTRETIEN DOIT ÊTRE ASSURÉ PAR UNE PERSONNE QUALIFIÉE EN CONSIDÉRANT L'ASPECT SÉCURITAIRE DES ÉQUIPEMENTS CONTRÔLÉS PAR CE PRODUIT. L'AJUSTEMENT ET/OU L'EXTRACTION DE CE PRODUIT PEUT OCCASIONNER DES À-COUPS AU PROCÉDÉ CONTRÔLE LORSQU'IL EST INSÉRÉ DANS UNE SYSTÈME ACTIF. CES À-COUPS PEUVENT ÉGALEMENT OCCASIONNER DES BLESSURES OU DES DOMMAGES MATÉRIELS.

## NOTICE

The information contained in this document is subject to change without notice.

Elsag Bailey, its affiliates, employees, and agents, and the authors and contributors to this publication specifically disclaim all liabilities and warranties, express and implied (including warranties of merchantability and fitness for a particular purpose), for the accuracy, currency, completeness, and/or reliability of the information contained herein and/or for the fitness for any particular use and/or for the performance of any material and/or equipment selected in whole or part with the user of/or in reliance upon information contained herein. Selection of materials and/or equipment is at the sole risk of the user of this publication.

This document contains proprietary information of Elsag Bailey, Elsag Bailey Process Automation, and is issued in strict confidence. Its use, or reproduction for use, for the reverse engineering, development or manufacture of hardware or software described herein is prohibited. No part of this document may be photocopied or reproduced without the prior written consent of Elsag Bailey.

---

## Preface

---

The NIAC02 Analog Input Calibration Module is required to simultaneously calibrate all eight inputs for the IMASM02 Analog Input Slave Module interfaced to an NIAI02 termination module. Calibration voltages pass from the IMAMM02 and IMAMM03 Analog Master Modules or an external millivolt calibration source to the IMASM02 slave module.

This manual explains how to install and use the NIAC02 module on the INFI 90<sup>®</sup> system. It contains sections that describe setup and cabling. The appendix contains information about the IMASM02 module.

## List of Effective Pages

---

Total number of pages in this manual is 23, consisting of the following:

<b>Page No.</b>	<b>Change Date</b>
Preface	Original
List of Effective Pages	Original
iii through vi	Original
1-1 through 1-5	Original
2-1 through 2-6	Original
3-1	Original
4-1 through 4-2	Original
5-1	Original
A-1	Original
Index-1	Original

When an update is received, insert the latest changed pages and dispose of the superseded pages.

**NOTE:** On an update page, the changed text or table is indicated by a vertical bar in the outer margin of the page adjacent to the changed area. A changed figure is indicated by a vertical bar in the outer margin next to the figure caption. The date the update was prepared will appear beside the page number.

---

## Safety Summary

---

### **GENERAL WARNINGS**

#### **Equipment Environment**

All components, whether in transportation, operation or storage, must be in a noncorrosive environment.

#### **Electrical Shock Hazard During Maintenance**

Disconnect power or take precautions to insure that contact with energized parts is avoided when servicing.

### **SPECIFIC CAUTIONS**

Remove modules from their module mounting unit slots before installing or removing a cable assigned to that slot. Failure to do so could result in damage to the module. (p. 2-3, 4-1)

It is strongly recommended that all power (cabinet, I/O, etc.) be turned off before doing any termination module wiring. Failure to do so could result in equipment damage. Do not apply power until all connections are verified. (p. 2-4, 4-1)

If input or output circuits are a shock hazard after disconnecting system power at the power entry panel, then the door of the cabinet containing these externally powered circuits must be marked with a warning stating that multiple power sources exist. (p. 2-5)

---

## Sommaire de Sécurité

---

**AVERTISSEMENTS  
D'ORDRE  
GÉNÉRAL****Environnement de l'équipement**

Ne pas soumettre les composants à une atmosphère corrosive lors du transport, de l'entreposage ou l'utilisation.

**Possibilité de chocs électriques durant l'entretien**

Débrancher l'alimentation ou prendre les précautions pour éviter tout contact avec des composants sous tension durant l'entretien.

**ATTENTIONS  
D'ORDRE  
SPÉCIFIQUE**

Retirer le module de son emplacement dans le châssis de montage des modules avant d'installer ou de retirer un câble assigné à cet emplacement. Un manquement à cette procédure pourrait endommager le module. (p. 2-3, 4-1)

Il est fortement recommandé que toutes les alimentations (armoire, E/S, etc.) soient coupées avant d'effectuer quelque raccord que ce soit sur une carte de raccordement. Un manquement à ces instructions pourrait causer des dommages à l'équipement. Ne pas rebrancher les alimentations avant d'avoir vérifié tous les raccordements. (p. 2-4, 4-1)

Si des circuits d'entrée ou de sortie sont alimentés à partir de sources externes, ils présentent un risque de choc électrique même lorsque l'alimentation du système est débranchée du panneau d'entrée l'alimentation. Le cas échéant, un avertissement signalant la présence de sources d'alimentation multiples doit être apposé sur la porte de l'armoire. (p. 2-5)

---

# Table of Contents

	<i>Page</i>
<b>SECTION 1 - INTRODUCTION</b> .....	<b>1-1</b>
OVERVIEW .....	1-1
INTENDED USER .....	1-1
MODULE DESCRIPTION .....	1-1
HARDWARE APPLICATION .....	1-1
FEATURES .....	1-2
INSTRUCTION CONTENT .....	1-3
HOW TO USE THIS MANUAL .....	1-3
REFERENCE DOCUMENTS .....	1-3
GLOSSARY OF TERMS AND ABBREVIATIONS .....	1-4
SPECIFICATIONS .....	1-4
NOMENCLATURE .....	1-5
<b>SECTION 2 - INSTALLATION</b> .....	<b>2-1</b>
INTRODUCTION .....	2-1
SPECIAL HANDLING .....	2-1
UNPACKING AND INSPECTION .....	2-2
SETUP/PHYSICAL INSTALLATION .....	2-2
Switch Settings .....	2-2
Cable Installation .....	2-2
Module Installation .....	2-4
Terminal Wiring .....	2-4
<b>SECTION 3 - MAINTENANCE</b> .....	<b>3-1</b>
INTRODUCTION .....	3-1
MAINTENANCE SCHEDULE .....	3-1
<b>SECTION 4 - REPAIR/REPLACEMENT PROCEDURES</b> .....	<b>4-1</b>
INTRODUCTION .....	4-1
REPLACEMENT PROCEDURES .....	4-1
<b>SECTION 5 - SUPPORT SERVICES</b> .....	<b>5-1</b>
INTRODUCTION .....	5-1
REPLACEMENT PARTS AND ORDERING INFORMATION .....	5-1
TRAINING .....	5-1
TECHNICAL DOCUMENTATION .....	5-1
<b>APPENDIX A - IMASM02 THERMOCOUPLE SLAVE INPUT MODULE</b> .....	<b>A-1</b>
INTRODUCTION .....	A-1

## List of Tables

<i>No.</i>	<i>Title</i>	<i>Page</i>
1-1.	Reference Documents .....	1-3
1-2.	Glossary of Terms and Abbreviations .....	1-4
1-3.	Specifications .....	1-4
1-4.	Nomenclature .....	1-5
2-1.	NIAC02 Cable Applications .....	2-3
3-1.	Maintenance Schedule.....	3-1
A-1.	Address Switch Settings (SW1) .....	A-1

## List of Figures

<i>No.</i>	<i>Title</i>	<i>Page</i>
1-1.	Application Example for the NIAC02 Module .....	1-2
2-1.	Cable Connections for the NIAC02 Module .....	2-3
2-2.	Terminal Assignments for the NIAC02 Module .....	2-5
A-1.	Address Select Switch (SW1) .....	A-1



---

# SECTION 1 - INTRODUCTION

---

## OVERVIEW

The NIAC02 Analog Input Calibration Module is required to simultaneously calibrate all eight inputs for the IMASM02 Analog Input Slave Module that interface to the NIAI02 termination modules. Calibration voltages pass from the IMAMM02 and IMAMM03 Analog Master Modules or an external millivolt calibration source to the IMASM02 slave module.

This manual explains the purpose, setup, handling precautions and steps to install the NIAC02 module. Calibrate the slave according to the IMAMM03 module product instruction. Refer to the **Table of Contents** to find the information. Refer to the **HOW TO USE THIS MANUAL** entry in this section to get started.

---

## INTENDED USER

System engineers and technicians should read this manual before installing and using the termination module. Put the module into operation only after reading and understanding this instruction.

---

## MODULE DESCRIPTION

The NIAC02 module is a single printed circuit board that uses one slot in an NTMU01 Termination Module Mounting Unit. The termination module (TM) has one card edge connector (P1) and one terminal block (TB1). It connects to a dedicated calibration slot in the MMU card cage through a cable.

---

## HARDWARE APPLICATION

The terminal blocks allow either an internal or external calibration source to be connected to the NIAC02 module to calibrate the zero and span of the slave inputs. The IMASM02 module must be physically moved to the dedicated MMU card cage calibration slot connected to the calibration module. An NIAC02 module is used to calibrate all eight inputs at one time. The NIAC02 calibration module is not required to calibrate individual channels with an external millivolt calibration source. Refer to the IMAMM03 module product instruction for single point calibration. Figure 1-1 shows an application example for the NIAC02 module.

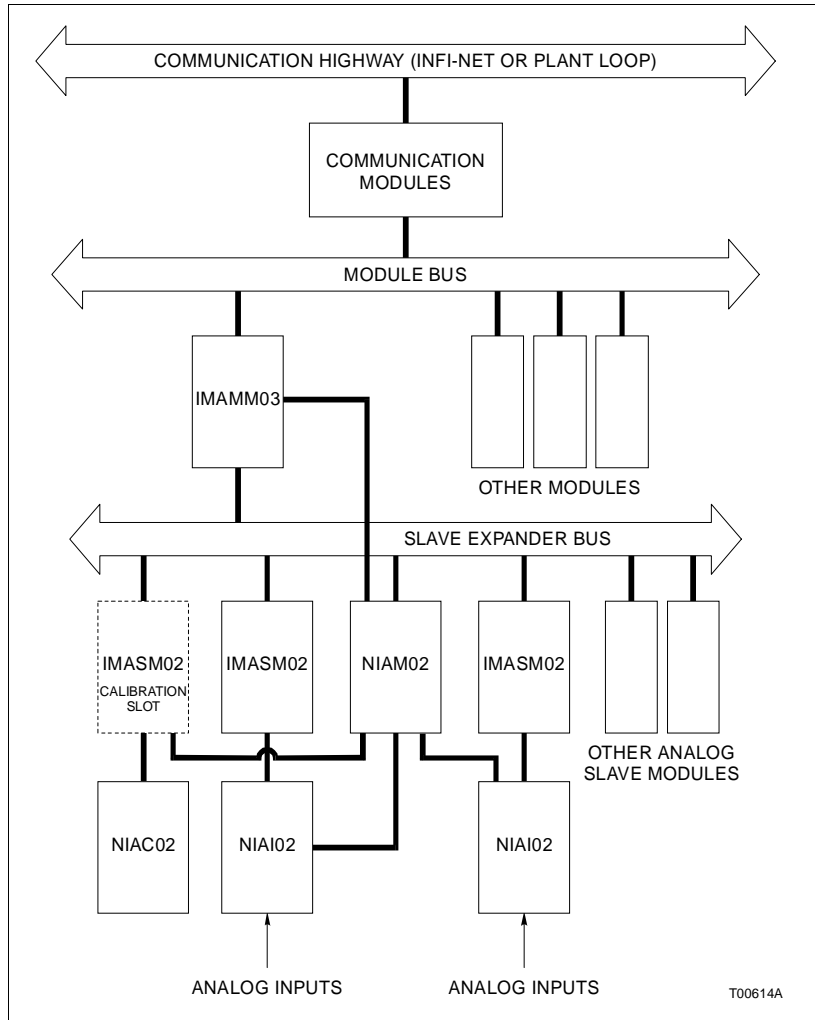

Figure 1-1. Application Example for the NIAC02 Module

## FEATURES

The design of the NIAC02 module, as with all INFI 90 devices, allows for flexibility in creating a process management system. Refer to the **NOMENCLATURE** entry of this section for the list of devices that can be used with the calibration module in an INFI 90 system.

- A standard factory-wired cable connects from the NIAC02 module to the calibration slot for the IMASM02 module to be calibrated.
- Signal wire terminals are at the front edge of the calibration module for internal or external millivolt source connection.
- Each calibration module fits in a standard termination mounting unit.

- Provides input calibration interface for the IMASM02 module.
- Switch selected internal or external calibration.

---

**INSTRUCTION CONTENT**

This manual has five sections and an appendix.

<b>Introduction</b>	Contains an overview of the features, description and specifications and a description of the NIAC02 module.
<b>Installation</b>	Describes cautions to observe when handling the calibration module. It shows the steps to install and connect the terminal wiring before applying power.
<b>Maintenance</b>	Provides a maintenance schedule.
<b>Repair/Replacement Procedures</b>	Details how to replace an NIAC02 module.
<b>Support Services</b>	Describes the support services (repair parts, training, documentation, etc.) available from Bailey Controls Company.
<b>Appendix A</b>	Describes the IMASM02 Thermocouple Slave Input Module.

---

**HOW TO USE THIS MANUAL**

Read this manual before handling the calibration module. Refer to the sections in this list as needed for more information.

1. Read **Section 2** before connecting the NIAC02 module.
2. Refer to **Appendix A** for the IMASM02 slave module.
3. Refer to **Section 3** for the maintenance schedule.
4. Refer to **Section 4** and **Section 5** when needed.

---

**REFERENCE DOCUMENTS**

Table 1-1 lists the reference documents for the NIAC02 module.

*Table 1-1. Reference Documents*

<b>Document Number</b>	<b>Description</b>
I-E96-205	Analog Master Module and Analog Slave Modules (IMAMM03 and IMASM01/02/03/04)
I-E96-437	Analog Master Termination Module (NIAM02)

**GLOSSARY OF TERMS AND ABBREVIATIONS**

Table 1-2 lists the glossary of terms for this manual.

*Table 1-2. Glossary of Terms and Abbreviations*

<b>Term</b>	<b>Definition</b>
Analog	Continuously variable as opposed to discretely variable.
Slave Module	One of a series of modules designed to perform high or low level operations as directed by a master module.
Thermocouple	A bimetallic sensor used for temperature measurements.
TM	Termination module. Provides input/output connection between plant equipment and the INFI 90/Network 90 <sup>®</sup> modules.
TMU	Termination mounting unit. A card cage that provides housing for INFI 90/Network 90 termination modules.

**SPECIFICATIONS**

Refer to Table 1-3 for the specifications of the NIAC02 termination module.

*Table 1-3. Specifications*

<b>Property</b>	<b>Characteristic/Value</b>
Power Requirements	No power is required by the NIAC02 module.
Mounting	Slides into a single slot in the NTMU01 termination mounting unit.
Environmental:	
Electromagnetic/ Radio Frequency Interference	No values available at this time. Keep cabinet doors closed. Do not use communication equipment closer than 2 meters from the cabinet.
Ambient Temperature	0° to 70° C (32° to 158° F).
Relative Humidity	5% to 90% ± 5% up to 55° C (131° F) (noncondensing). 5% to 40% ± 5% up to 70° C (158° F) (noncondensing).
Atmospheric Pressure	Sea level to 3 km (1.86 mi).
Air Quality	Noncorrosive.
Cooling Requirements	No cooling is necessary when used in Bailey Controls cabinets and operated within stated limits.
Certification	CSA certified for use as process control equipment in an ordinary (non-hazardous) location.
Specifications are subject to change without notice.	

<sup>®</sup> Registered trademark of Elsasg Bailey Process Automation.

---

**NOMENCLATURE**

Table 1-4 lists the nomenclatures of the modules and equipment that can be used with the NIAC02 module.

*Table 1-4. Nomenclature*

<b>Nomenclature</b>	<b>Description</b>
IMASM02	Thermocouple and Millivolt Input Slave Module
NIAM02	Analog Master Termination Module
NKTM01	Cable, Termination Module (Ribbon)
NKTU02	Cable, Termination Module (PVC)
NKTU12	Cable, Termination Module (non-PVC)
NTMU01/02	Termination Mounting Unit
258436A1	Cable retaining kit used when a round cable connects to the TMU card cage.

---

## SECTION 2 - INSTALLATION

---

### INTRODUCTION

This section explains how to install the NIAC02 Analog Input Calibration Module. Read, understand and complete the steps in the order they appear before operating the NIAC02 module.

---

### SPECIAL HANDLING

Observe these steps when handling electronic circuitry:

**NOTE:** Always use the Bailey Controls Field Static Kit (part number 1948385A1 - consisting of two wrist straps, ground cord assembly, alligator clip and static dissipating work surface) when working with modules. The kit is designed to connect the technician and the static dissipating work surface to the same ground point to prevent damage to the modules by electrostatic discharge.

Use the static grounding wrist strap when installing and removing modules. Static discharge may damage MOS devices on modules in the cabinet. Use grounded equipment and static safe practices when working with modules.

1. **Use Static Shielding Bag.** Keep the modules in the static shielding bag until you are ready to install them in the system. Save the bag for future use.
2. **Ground Bag Before Opening.** Before opening a bag containing an assembly with CMOS devices, touch it to the equipment housing or ground to equalize charges.
3. **Avoid Touching Circuitry.** Handle assemblies by the edges; avoid touching the circuitry.
4. **Avoid Partial Connection of CMOS Device.** Verify that all devices connected to the modules are properly grounded before using them.
5. **Ground Test Equipment.**
6. **Use an Antistatic Field Service Vacuum.** Remove dust from the module if necessary.
7. **Use a Grounded Wrist Strap.** Connect the wrist strap to the appropriate grounding plug on the power entry panel. The grounding plug on the power entry panel is connected to the cabinet chassis ground.
8. **Do Not Use Lead Pencils to Set Dipswitches.** To avoid contamination of switch contacts that can result in circuit board malfunction, do not use a lead pencil to set a dipswitch.

---

## UNPACKING AND INSPECTION

These are steps to follow for general handling:

1. Examine the module to make sure that no damage has occurred in transit.
2. Notify the nearest Bailey Controls sales office of any damage.
3. File a claim for any damage with the shipping company that handled the shipment.
4. Use the original packing material or container to store the module.
5. Store the module in a place with clean air; free from extremes of temperature and humidity.

---

## SETUP/PHYSICAL INSTALLATION

This section explains how to configure and install the NIAC02 module. The required procedures are installing the termination module and connecting the calibration signal wiring and termination cables.

The calibration slot should be as close to the master module as possible for both internal and external calibration.

---

### **Switch Settings**

The calibration select switch selects the source for the calibration voltage. When set to INT CAL, the switch selects the internal calibration terminals (wired from the NIAM02 module) on TB1 as the source for the calibration voltage. When set to EXT CAL, the switch selects the external calibration terminals (wired from the external millivolt source) on TB1 as the source for the calibration voltage.

---

### **Cable Installation**

Use the NKTU02, NKTU12, or NKTMO1 cable to connect the NIAC02 module to an empty slot in the module mounting unit. This slot will be the calibration slot. To calibrate an IMASM02 Analog Slave Module, remove it from its normal position and insert it into the calibration slot. The NKTMO1 cable is a flat ribbon cable. The NKTU02 cable is a round, shielded cable with PVC jacket. The NKTU12 cable is a round, shielded cable with non-PVC jacket.

Figure 2-1 shows the cabling from the NIAC02 calibration module to the IMASM02 slave module. Table 2-1 lists the NIAC02 module cable connections.

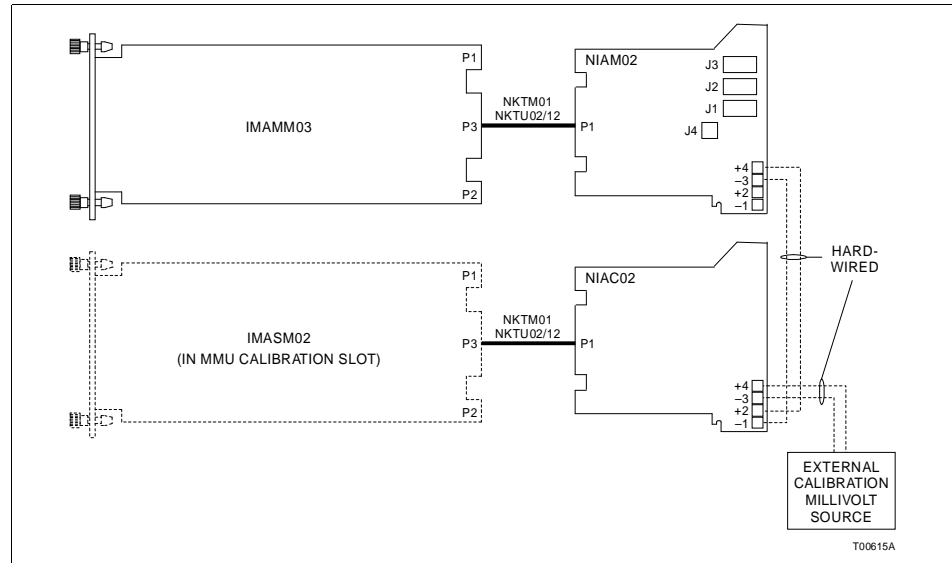

Figure 2-1. Cable Connections for the NIAC02 Module

Table 2-1. NIAC02 Cable Applications

Nomenclature/Description	Application	Connector	Maximum Length
NKTU02 cable (PVC Jacket)	Connects NIAC02 module to calibration slot	P1 on NIAC02 module to MMU backplane	61 (200 ft)
NKTU12 cable (non-PVC Jacket)			
NKTM01 cable (ribbon)	Connects NIAC02 module to calibration slot	P1 on NIAC02 module to MMU backplane	30 m (100 ft)
Twisted wire pair	Connects NIAC02 module to NIAM02	TB1 terminal 3 and 4 on NIAM02 module to TB1 1 and 2 on NIAC02 module	—

<b>CAUTION</b>	<b>Remove modules from their module mounting unit slots before installing or removing a cable assigned to that slot. Failure to do so could result in damage to the module.</b>
<b>ATTENTION</b>	<b>Retirer le module de son emplacement dans le chassis de montage des modules avant d'installer ou de retirer un câble assigne a cet emplacement. Un manquement à cette procédure pourrait endommager le module.</b>

To install the cable follow these steps.

1. Pull the slave module in the calibration slot several inches from the MMU backplane.
2. If round type cables are already installed in the TMU card cage, remove the cable retaining bracket (Bailey part number 258436A1). Use NKTU02, NKTU12 or NKTM01 cables.



3. Insert the J2 end of the termination module cable into the MMU backplane slot assigned to the slave module calibration slot. The cable should latch securely in place. Card edge connector P3 of the slave module connects to this end of the cable.
4. If NKTU02 or NKTU12 cables are used, connect the shield wire extending from the J2 end of the cable to the shield bar.
5. Insert the J1 end of the cable into the TMU backplane slot assigned to the NIAC02 module. The cable should latch securely in place. Card edge connector P1 of the NIAC02 module connects to this end of the cable.
6. Replace or add the cable retaining bracket if round type cables are installed in the TMU card cage.

---

### Module Installation

The NIAC02 module inserts into a standard INFI 90 termination mounting unit (TMU) and occupies one slot. To install the NIAC02 module:

1. Verify the slot assignment of the NIAC02 module.
2. Align the NIAC02 module with the guide rails in the TMU card cage and insert the module.

---

### Terminal Wiring

The NIAC02 module connects to the internal or external calibration source through a twisted pair. The NIAC02 module connects to the NIAM02 module for an internal calibration source. The NIAC02 module connects to an external calibration source for an external calibration. Connect the wiring from the NIAC02 module to the NIAM02 module terminals for internal calibration. Figure 2-2 shows the terminal locations and assignments.

#### CAUTION

**It is strongly recommended that all power (cabinet, I/O, etc.) be turned off before doing any termination module wiring. Failure to do so could result in equipment damage. Do not apply power until all connections are verified.**

#### ATTENTION

**Il est fortement recommande que toutes les alimentations (armoire, E/S, etc.) soient coupees avant d'effectuer quelque raccord que ce soit sur une carte de raccordement. Un manquement a ces instructions pourrait causer des dommages a l'equipment. Ne pas rebrancher les alimentations avant d'avoir verifie tous les raccords.**

**CAUTION**

If input or output circuits are a shock hazard after disconnecting system power at the power entry panel, then the door of the cabinet containing these externally powered circuits must be marked with a warning stating that multiple power sources exist.

**ATTENTION**

Si des circuits d'entree ou de sortie sont alimentes a partir de sources externes, ils presentent un risque de choc electrique meme lorsque l'alimentation du systeme est debranchee du panneau d'entree l'alimentation. Le cas echeant, un avertissement signalant la presence de sources d'alimentation multiples doit etre appose sur la porte de l'armoire.

Use twisted wire pair capable of carrying 100 millivolts to connect the calibration source to the NIAC02 module. Keep the wire as short as possible and note the signal polarity. To connect calibration inputs, follow these steps:

1. Remove the front cover.
2. Insure that the NIAC02 module is pulled out far enough to gain access to the terminal block.
3. Feed the wiring into the terminal strip area from the connected NIAM02 module or from an external source and connect them to the appropriate terminals: TB1 terminals 1 and 2 are used for internal source connection, TB1 terminals 3 and 4 are used for external source connection.

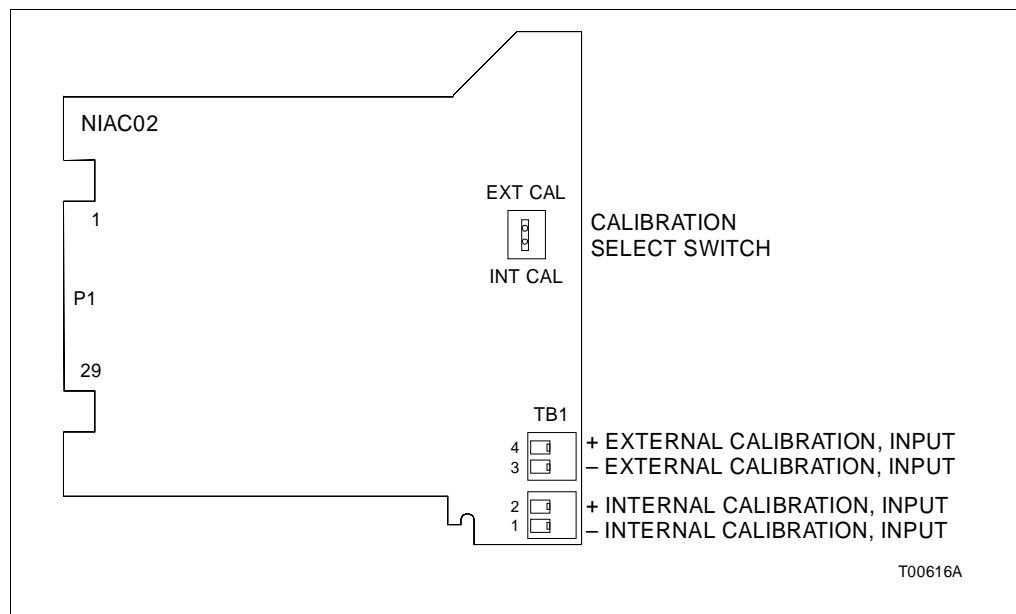

Figure 2-2. Terminal Assignments for the NIAC02 Module

4. Insert the module until it locks securely into place.
5. Connect the other end of the twisted pair to TB1 terminals 3 and 4 on the NIAM02 module for internal calibration or to the external millivolt source for external calibration.
6. Replace the front cover.

The NIAC02 module is ready for operation if:

1. The circuit board is mounted in the termination mounting unit.
2. All required cables are connected to the calibration module.
3. All required wires are connected to the calibration module.

---

## SECTION 3 - MAINTENANCE

---

### **INTRODUCTION**

The NIAC02 Analog Input Calibration Module requires limited maintenance. This section contains a maintenance schedule.

---

### **MAINTENANCE SCHEDULE**

Execute the tasks in Table 3-1 at the specified intervals.

*Table 3-1. Maintenance Schedule*

<b>Task</b>	<b>Interval</b>
Clean and tighten all power and grounding connections.	Every 6 months or during plant shutdown, whichever occurs first.
Use a static safe vacuum cleaner to remove dust from: Termination mounting unit. Calibration module.	

---

## SECTION 4 - REPAIR/REPLACEMENT PROCEDURES

---

### INTRODUCTION

This section explains the replacement procedures for the NIAC02 Analog Input Calibration Module. No special tools are required to replace the module.

---

### REPLACEMENT PROCEDURES

If an NIAC02 module is faulty, replace it with a new one. **Do not** try to repair the module. Replacing components may affect performance and certification.

**CAUTION**

It is strongly recommended that all power (cabinet, I/O, etc.) be turned off before doing any termination module wiring. Failure to do so could result in equipment damage. Do not apply power until all connections are verified.

**ATTENTION**

Il est fortement recommande que toutes les alimentations (armoire, E/S, etc.) soient coupees avant d'effectuer quelque raccord que ce soit sur une carte de raccordement. Un manquement a ces instructions pourrait causer des dommages a l'equipment. Ne pas rebrancher les alimentations avant d'avoir verifie tous les raccordements.

**CAUTION**

Remove modules from their module mounting unit slots before installing or removing a cable assigned to that slot. Failure to do so could result in damage to the module.

**ATTENTION**

Retirer le module de son emplacement dans le chassis de montage des modules avant d'installer ou de retirer un câble assigne a cet emplacement. Un manquement à cette procédure pourrait endommager le module.

To replace an NIAC02 termination module:

1. Turn off power to the INFI 90 cabinet.
2. Remove the calibration module front cover.
3. Pull the termination module several inches from the TMU backplane.
4. Label and remove all wiring from the terminal block.
5. Slide the calibration module out of the cabinet.

6. Slide the new calibration module into the same slot as the module that was removed.
7. Connect and verify all wiring removed in Step 4.
8. Verify that wiring and cabling to the calibration module is correct.
9. Fully insert the calibration module into the TMU card cage.
10. Replace the calibration module front cover.
11. Turn on the cabinet power supply that provides power and turn on any external power supplies providing I/O power.

---

## SECTION 5 - SUPPORT SERVICES

---

### *INTRODUCTION*

Bailey Controls Company is ready to help in the use, application and repair of its products. Contact the nearest sales office to make requests for sales, applications, installation, repair, overhaul and maintenance contract services.

---

### *REPLACEMENT PARTS AND ORDERING INFORMATION*

When making repairs, order replacement parts from a Bailey Controls sales office. Provide this information:

1. Part description, part number and quantity.
2. Model and serial numbers (if applicable).
3. Bailey instruction manual number, page number and reference figure that identifies the part.

Order parts without commercial descriptions from the nearest Bailey Controls Company sales office.

---

### *TRAINING*

Bailey Controls has a modern training facility available for training your personnel. On-site training is also available. Contact a Bailey Controls sales office for specific information and scheduling.

---

### *TECHNICAL DOCUMENTATION*

Additional copies of this manual, or other Bailey Controls Company manuals, can be obtained from the nearest Bailey Controls Company sales office at a reasonable charge.

# APPENDIX A - IMASM02 THERMOCOUPLE SLAVE INPUT MODULE

## INTRODUCTION

The IMASM02 Thermocouple Analog Slave Input Module uses an NIAC02 module to simultaneously calibrate the thermocouple or millivolt inputs. This appendix contains figures and tables that show the dipswitch location on the IMASM02 module and its settings. This information is provided as a quick reference guide for personnel installing the NIAC02 module. Figure A-1 shows the IMASM02 module address select switch (SW1). Table A-1 lists the binary addresses for setting SW1. Refer to the IMAMM03 module instruction for more detailed information to install and configure the slave.

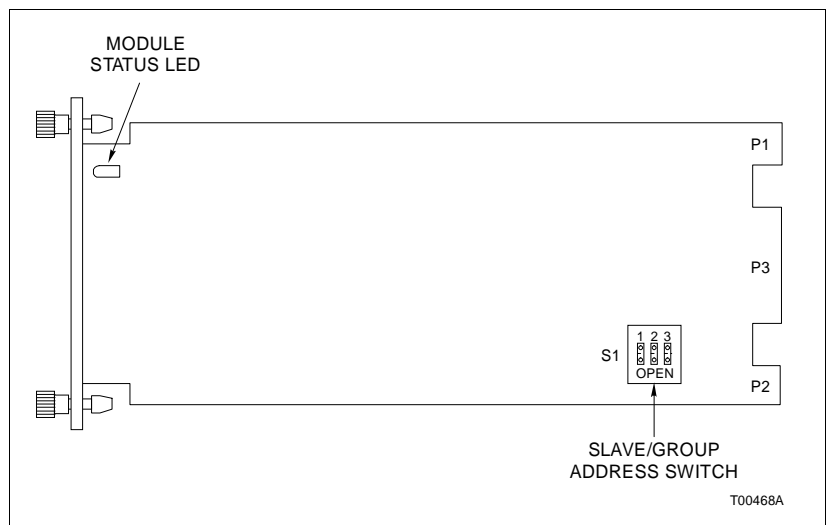

Figure A-1. Address Select Switch (SW1)

Table A-1. Address Switch Settings (SW1)

Address	MSB			Address	LSB		
	1	2	3		1	2	3
0	0	0	0	4	1	0	0
1	0	0	1	5	1	0	1
2	0	1	0	6	1	1	0
3	0	1	1	7	1	1	1

OPEN = OFF = 1  
CLOSED = ON = 0+



---

# Index

---

<b>C</b>	
Cables .....	1-5, 2-2
<b>G</b>	
Glossary .....	1-4
<b>I</b>	
I/O wiring .....	2-4
Installation .....	2-2
Instruction content .....	1-3
Intended user .....	1-1
<b>M</b>	
Maintenance schedule .....	3-1
<b>O</b>	
Overview .....	1-1
<b>R</b>	
References .....	1-3

Related equipment.....	1-5
Replacement parts/ordering information.....	5-1
Replacement procedures.....	4-1
<b>S</b>	
Setup.....	2-2
Spare parts .....	5-1
Specifications.....	1-4
<b>T</b>	
Technical documentation .....	5-1
Training.....	5-1
<b>U</b>	
Unpacking and inspection.....	2-2
<b>W</b>	
Wiring.....	2-5

Visit *Elsag Bailey* on the World Wide Web at <http://www.bailey.com>

---

Our worldwide staff of professionals is ready to meet *your* needs for process automation.  
For the location nearest you, please contact the appropriate regional office.

**AMERICAS**

29801 Euclid Avenue  
Wickliffe, Ohio USA 44092  
Telephone 1-216-585-8500  
Telefax 1-216-585-8756

**ASIA/PACIFIC**

152 Beach Road  
Gateway East #20-04  
Singapore 189721  
Telephone 65-391-0800  
Telefax 65-292-9011

**EUROPE, AFRICA, MIDDLE EAST**

Via Puccini 2  
16154 Genoa, Italy  
Telephone 39-10-6582-943  
Telefax 39-10-6582-941

**GERMANY**

Graefstrasse 97  
D-60487 Frankfurt Main  
Germany  
Telephone 49-69-799-0  
Telefax 49-69-799-2406